

**ADF400L**  
**Series Multi User Electric Energy Meter**

Installation and operation manual V1.8

# **Declaration**

Acrel owns the copyright of this Manual. Any information in any paragraph or section of this Manual shall not be extracted, copied, reproduced or otherwise distributed in any way. Otherwise, you will be responsible for all consequences.

All rights are reserved.

Specifications of the product described herein are subject to modification without notice. Please consult your local agent for the latest specifications before placing a purchase order.

# Contents

1 Overview .....	1
2 Product specifications .....	1
3 The main function .....	2
4 Technical parameter .....	3
5 Outline and installation dimensions (unit: mm) .....	4
6 Wiring and installation .....	6
7 Function Description .....	9
8 Show description .....	10
9 Communication description .....	17
10 Common troubleshooting .....	36

## 1 Overview

The ADF400L series multi-user electric energy meter can achieve up to 12 three-phase or 36 single-phase direct access measurement or 12 three-phase mutual inductor access measurement, a hybrid of direct access and mutual inductor access through module combination measurement method. This series of electric energy meters are popular among communities, schools, enterprises, etc. due to their high accuracy, centralized installation, centralized management, high installation flexibility, and non-interference.

## 2 Product specifications

### 2.1 Product naming

ADF400L-□H□S□D□□

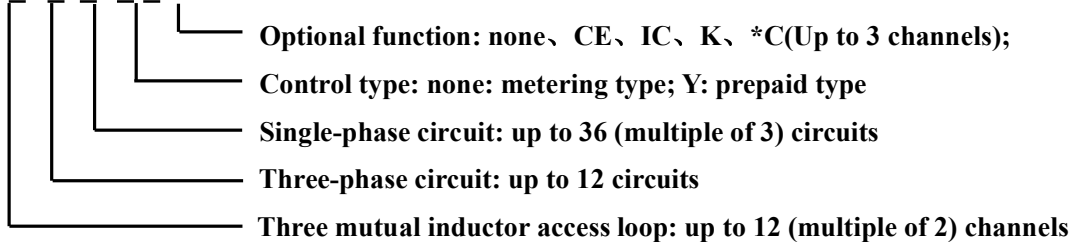

- Note: 1、 The product consists of main module, direct access module and transformer access module;  
2、 The product leaves the factory according to the module combination method;  
3、 The maximum combination of products can achieve 12 three-phase measurements (3 single-phase can be converted into 1 three-phase loop);

### 2.2 Product module description

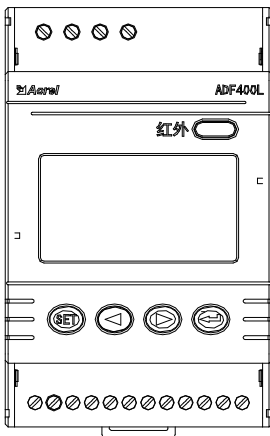

#### Main module

- 1、 Three-phase 3\*220/380V power supply to provide working power for the back-end measurement module;
- 2、 Man-machine interface: LCD and button programming;
- 3、 Infrared communication;
- 4、 RF card swiping (IC function);
- 5、 2 RS485 network communication (\*C function);
- 6、 RS485 communication for No. 3 extended wireless module (RJ45 connection mode );
- 7、 Up to 2DI/2DO (K function);
- 8、 Up to 1 Ethernet communication (CE function);

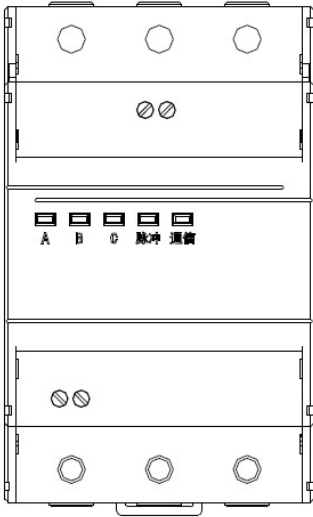

**Direct access to the measurement module**

- 1、 It can realize one-way three-phase 3\*10 (80) measurement or three-way single-phase 10 (80) A measurement;
- 2、 1 active energy pulse output;
- 3、 Three-phase working status, pulse and communication status LED indication;

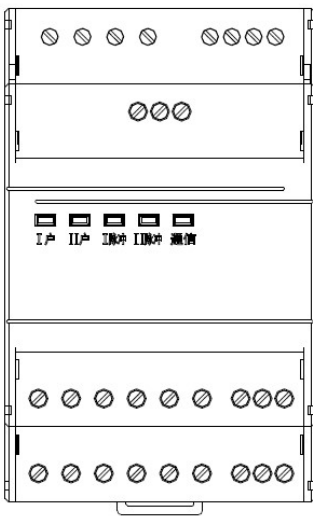

**Transformer access measurement module**

- 1、 Two-way three-phase 3\*1 (6) A measurement can be realized;
- 2、 2 active energy pulse output;
- 3、 2 three-phase working status, pulse and communication status LED indication;
- 4、 Up to 2DI/4DO function (K function);

3 The main function

3.1 Prepaid

Features	Function Description
Energy metering	Total active energy, forward and reverse active energy, multi-rate active energy measurement
Electricity measurement	U、 I
	P、 Q、 S、 PF、 F
LCD display	8-digit segment LCD display, backlight display
Button programming	Key programmable communication, number of loops, single three-phase mode, external control mode and other parameters
Pulse output	Active pulse output
Multiple rate	Support 4 time zones, 2 time slots, 14 daily time slots, 4 rates
	Date, time, day of the week
Main module communication	Infrared communication
	Up to 3 channels of communication: RS485 interface,

	Also support Modbus
Prepaid agreement (remote, radio frequency card)	Cost control (including forward active power and reverse active power)
	Time control
	Negative control (malignant load identification)
	Strong control
Recharge record	20 Article

### 3.2 Metering type

Features	Function Description
Display method	LCD (Field)
Energy metering	Active energy metering (Forward and reverse) , Reactive power measurement (Forward and reverse) ,
Electricity measurement	Voltage, current (zero sequence current), power factor, frequency, active power, reactive power, apparent power
Harmonic function	Total harmonic content, sub-harmonic content (2~31 times)
Three-phase unbalance	Voltage and current unbalance
DI/DO	Main module 2DI2DO
	Transformer access to the slave module 2DI4DO (direct access to the slave module without)
LED Instructions	Pulse light indication
Communication	Infrared communication
	RS485 interface (main module) supports MODBUS
Historical power	Historical Electricity in Last December

## 4 Technical parameter

technical parameter		model	ADF400L-□H□S□D(Y)- □
Auxiliary power	Voltage	Three-phase 3*220V/380V power supply (for single-phase power supply, short-circuit terminals 1, 2, and 3 on the instrument)	
	Power consumption	≤10W	
Voltage input	Rated voltage	3×220/380V、3×57.7/100V、	
	Reference frequency	50Hz	
Current input	Input Current	3×1(6)A(Instrument transformer access), 3*10 (80) (direct access)	
	Starting current	1%Ib	
Measuring performance	measurement accuracy	0.5s level	
	Clock accuracy	≤0.5s/d	
Pulse	Pulse output	Each three-phase metering module has 1 active energy pulse	
	Pulse Width	80ms±20ms	
	Pulse constant	3×1(6)A specification 6400 imp/kWh	
3×10(80)A specification 400 imp/kWh			

Switch	Main module	Main module 2DI+2DO, Among them, DI is dry contact input
	Slave module	Transformer access slave module 2DI+4DO, Among them, DI is 220V wet contact input
Communication	Infrared interface	Infrared communication
	RS485 interface	MODBUS-RTU
	Ethernet interface	Modbus-TCP、TCP/IP
Surroundings	temperature	Operating temperature: $-20^{\circ}\text{C}\sim+60^{\circ}\text{C}$ , storage temperature: $-30^{\circ}\text{C}\sim+70^{\circ}\text{C}$
	humidity	$\leq 95\%RH$ , No condensation, no corrosive gas place
	altitude	$\leq 2000\text{m}$

## 5 Outline and installation dimensions (unit: mm)

The electric energy meter should be installed in a ventilated and dry place indoors, using 35mm standard guide rail installation.

### 5.1 Dimensions

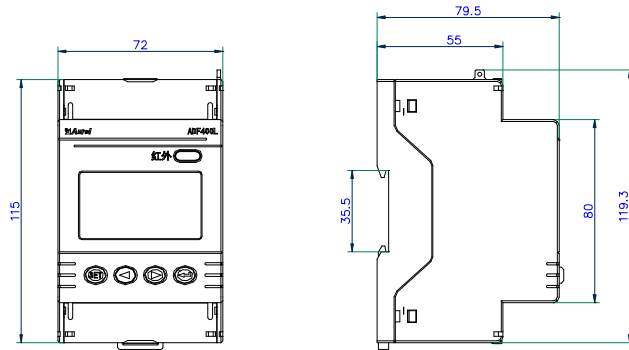

Main module size

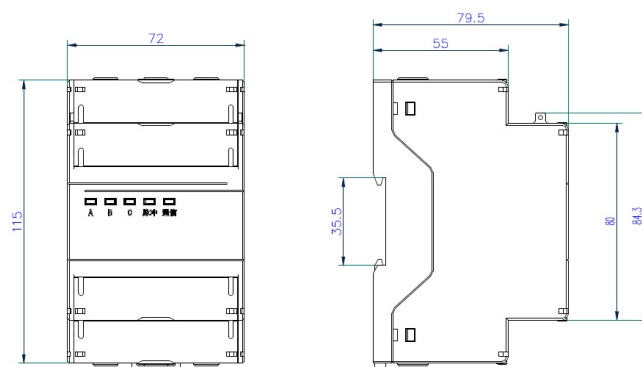

Slave module (direct access or transformer access module) size

### 5.2 Module combination installation method

The connection method between the master module and the slave module is connected by a network cable, and the connection network cable needs to use the meter's own network cable;

#### 5.2.1 The slave modules are directly connected to the module

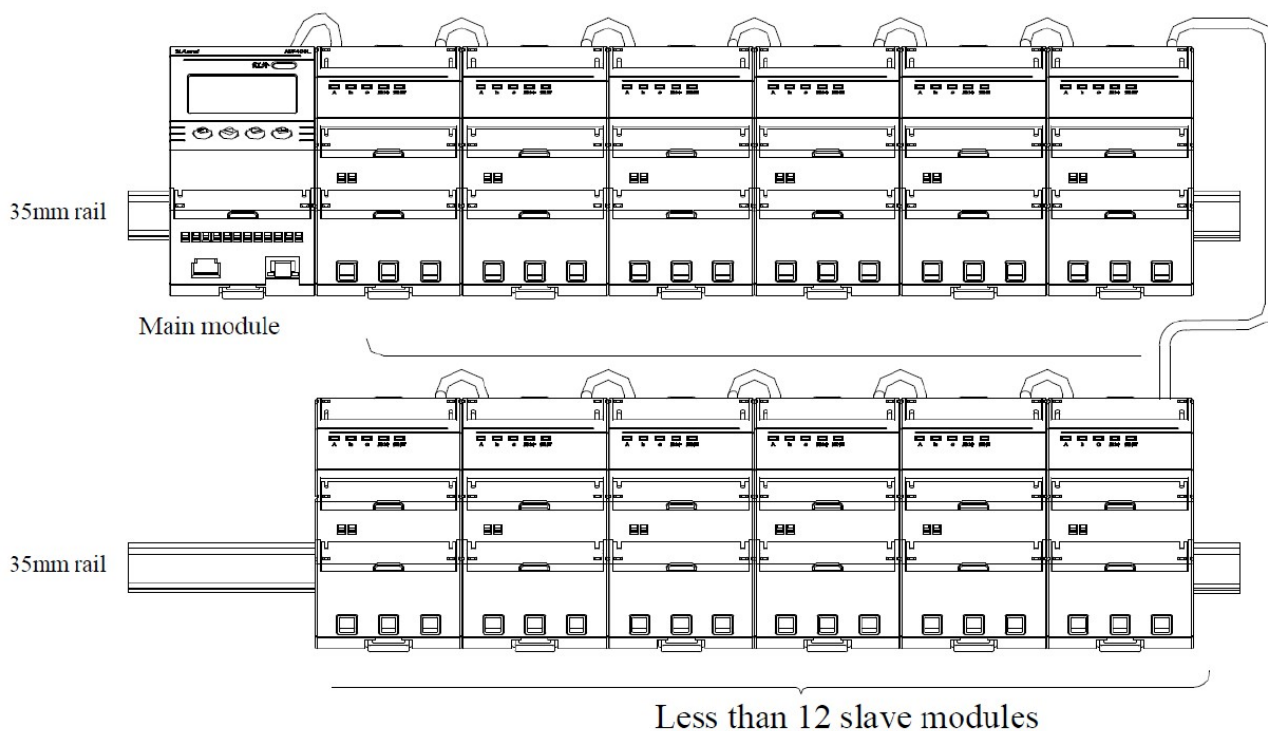

Note:

- 1、 When the module is installed in multiple rows, refer to the connection method of double row installation in 5.2.1;
  - 2、 When there are three-phase and single-phase applications in the module at the same time, the order of arrangement is, main module three-phase direct access module single-phase direct access module;
- 5.2.2 The slave modules are all transformer access modules

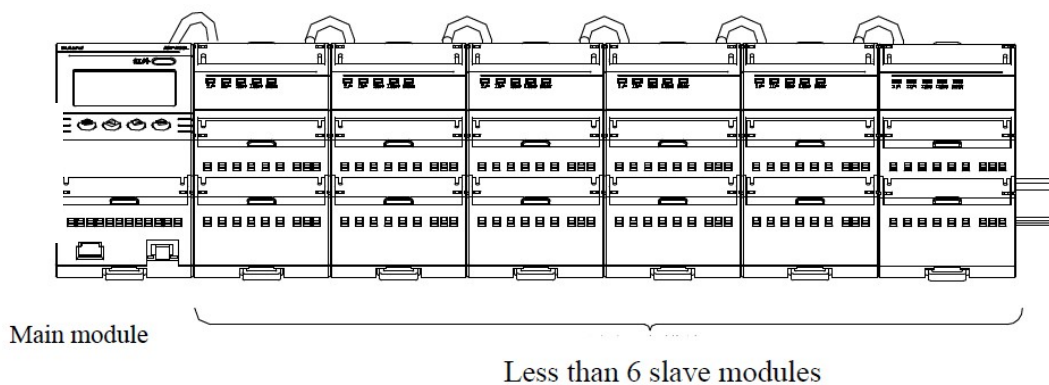

Note: Refer to the connection method of double-row installation in 5.2.1 when the module is installed in multiple



rows;

5.2.3 The slave module is a mixed connection of the secondary access measurement module and the direct access measurement module

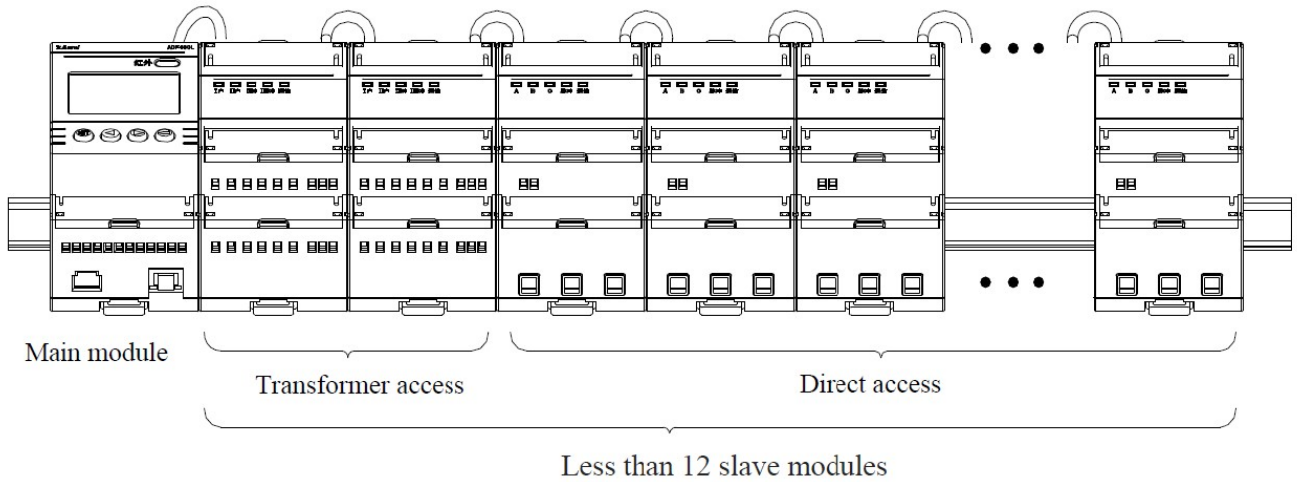

Note:

- When the module is installed in multiple rows, please refer to 5.2.1 for the connection method of double row installation.;
- When there are three-phase and single-phase applications in the direct module at the same time, the order of arrangement is: main module    mutual inductor access module    three-phase direct access module    single-phase direct access module

## 6 Wiring and installation

### 6.1 Main module

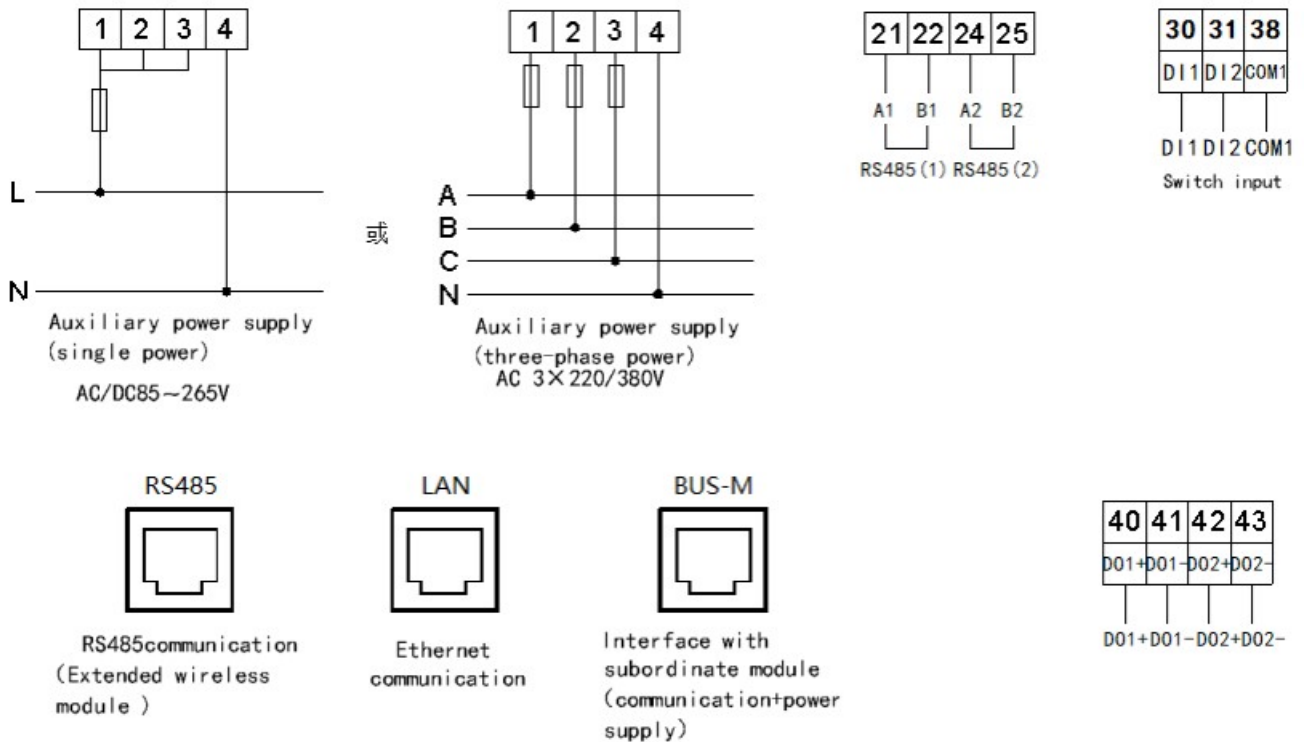

## 6.2 Transformer access module

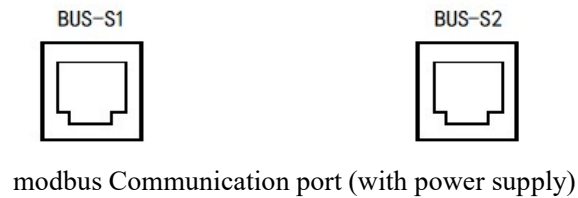
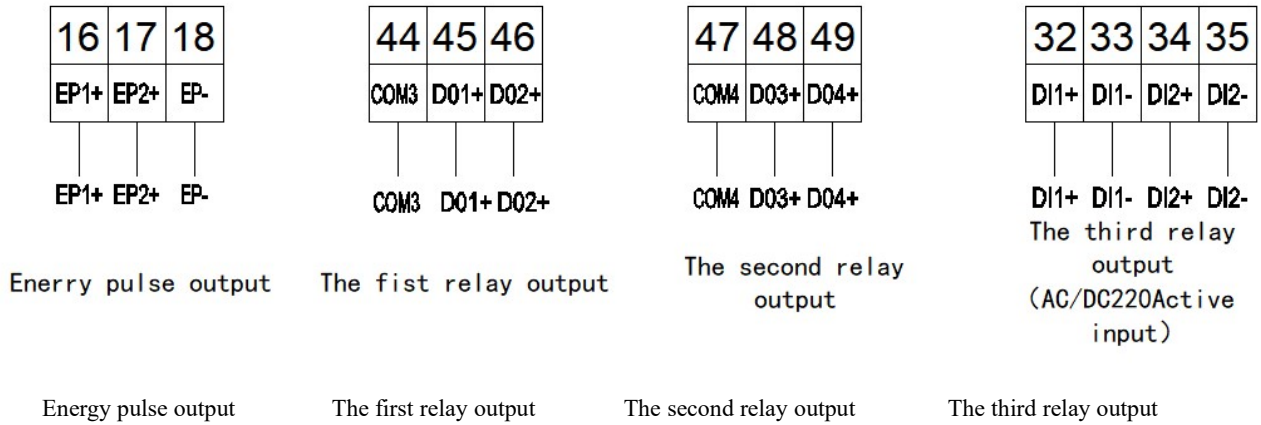
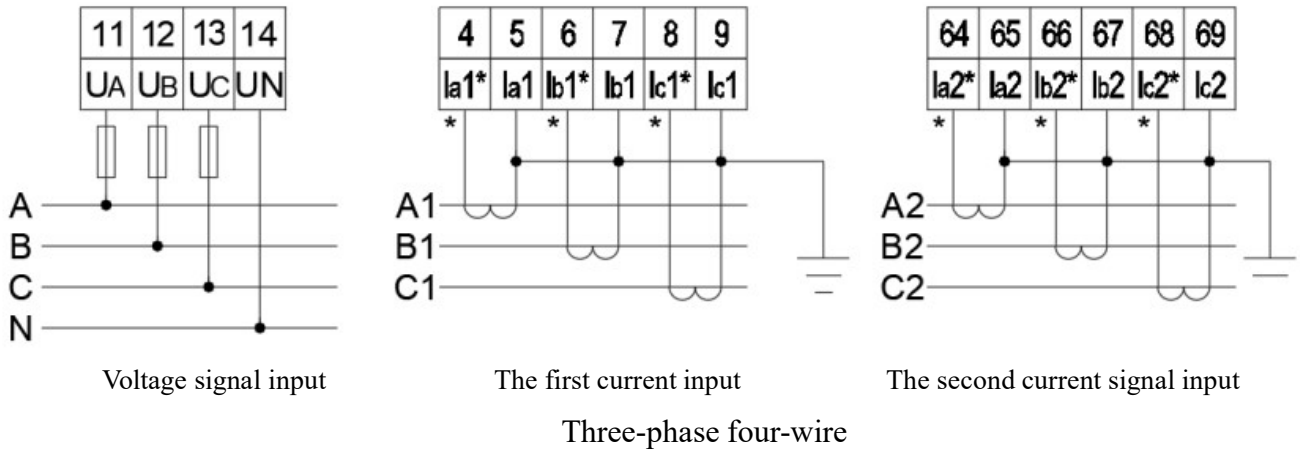

## 6.3 Direct access to the module

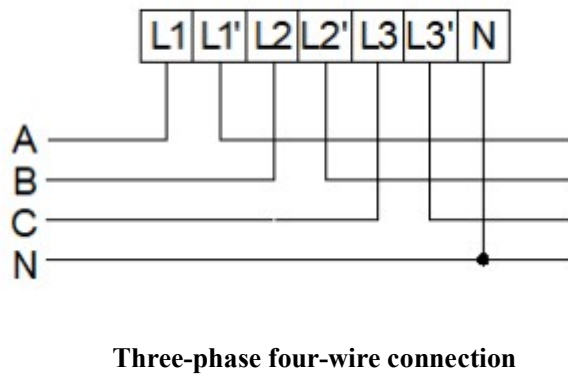



EP+ EP-

Active energy pulse output

#### 6.4 Wiring diagram

Note: When directly connecting to the module, the n-wire must be connected. Pay attention to the position of the n-wire (two n-wire terminals are connected)

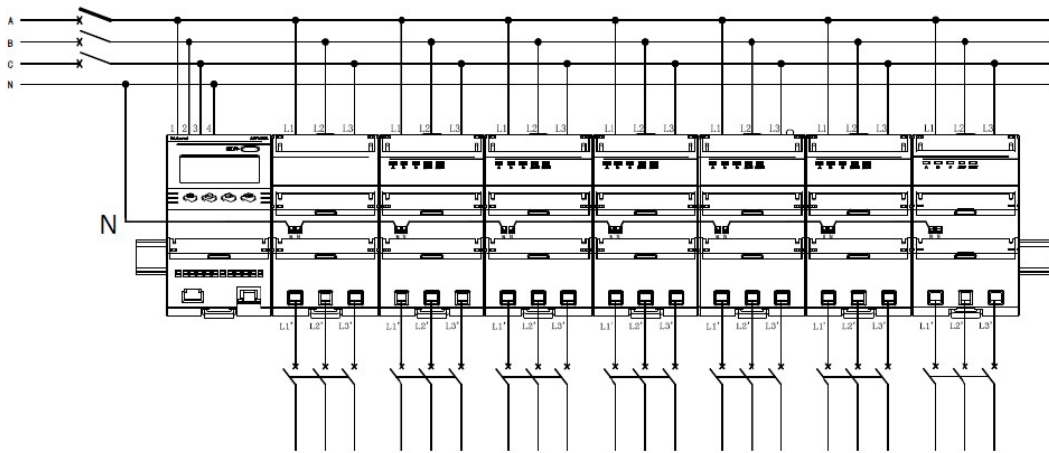

2 channels of three items direct access diagram

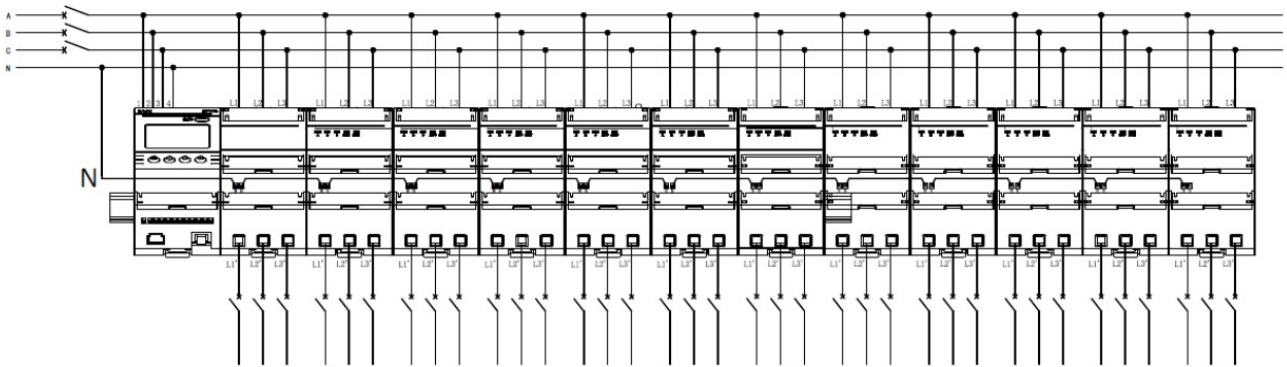

36-channel single item direct access diagram

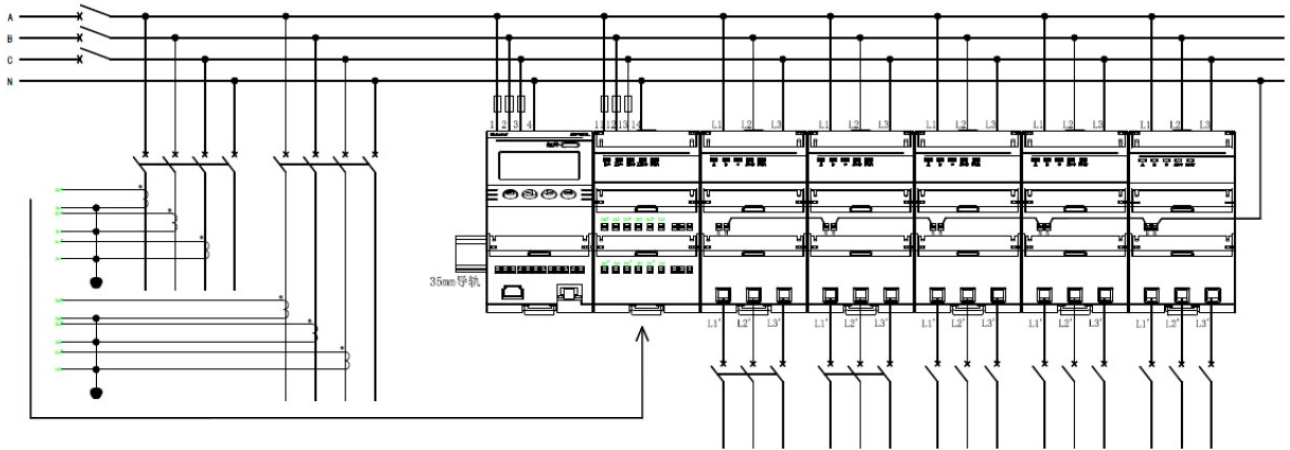

2 channels of transformer access + 2 channels of three items direct access + 6 channels of single item direct input

### 6.5 Wiring inspection

When there are three-phase and single-phase in the module, the sequence is: Main module-> Transformer access module-> Three phase direct access module-> single phase direct access module. Generally, there will be serial numbers on the slave modules when they leave the factory, which can be accessed according to the sequence of serial numbers on the slave modules.

After successful wiring, power on inspection is needed to ensure normal communication between master module and slave module. First, make sure that the number of loops is set correctly. You can press the second key from the left of the main module to switch the number of households to check whether the number of households displayed in the main module corresponds to the actual access. Then, you can press the second key from the left of the main module to switch the number of households to check whether the communication of each household is normal. Under normal circumstances, the blank below the number of households means that the communication is normal. If there is an error under the account number, check it according to the following table:

Display	Error description
Err1	Same type module address error
Err2	Module location does not match module type
Err3	Module missing

## 7 Function Description

### 7.1 Energy metering

The multi-user electric energy meter can measure the total power consumption (forward + reverse), forward power consumption and reverse power consumption of each user.

### 7.2 Relay control (prepaid type only)

#### 7.2.1 No fee shutdown (prepaid control)

The multi-user electric energy meter can be set to alarm power 1 and alarm power 2. When the user uses

electricity, the user's total power consumption is incremented, and the user's remaining power is decremented. When the user's remaining power is less than the alarm power 1, the LCD displays "please buy electricity". When the remaining power is less than the alarm power 2, the electric energy meter will automatically switch off the power, and the power supply can be restored after a period of time. Recovery time can be set to 0-255S, the value is 0 without power.

#### **7.2.2 Timed power-off (time control)**

The multi-user electric energy meter can control the user's electricity consumption time. The electric energy meter can set the automatic power-off and power-on time through the background management software to facilitate the user's electricity management.

#### **7.2.3 Overload power failure (negative control)**

The multi-user electric energy meter can set the user's maximum load power. When the user's actual power is greater than the set value, the electric energy meter automatically cuts off the power supply circuit of the user, the power does not exceed the maximum load power set value, and the customer has a vicious load identification requirement. The electric energy meter can automatically judge. If it is judged to be a vicious load, the user's power supply will be cut off. After a period of time (settable), the power supply can be automatically restored.

#### **7.2.4 Forced power off (forced control)**

The multi-user electric energy meter can be controlled by the back-end management system for forced power off and power transmission, so that the management center can handle emergencies in time.

Note: Among the above four controls, when the forced control is turned on, the other controls are invalid.

## **8 Show description**

Under normal circumstances, the energy meter will display the remaining amount and power consumption by default after power-on, as shown in Figure 1, Figure 2, and Figure 3. There are also two modes of swiping card display and button display. When the energy meter is in the card swiping display mode and swiping the card is wrong, the button display is invalid.

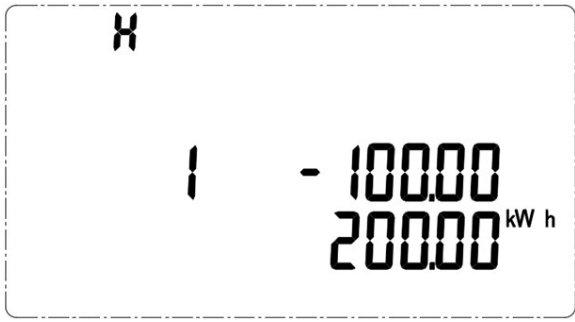

Figure 1

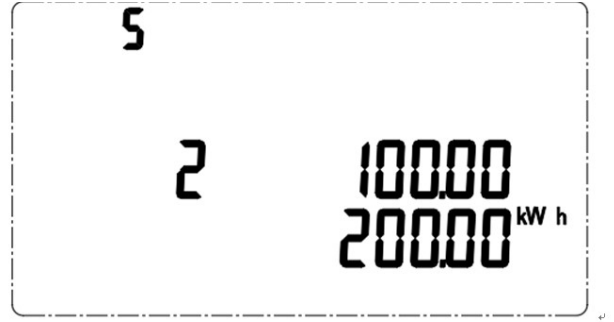

Figure 2

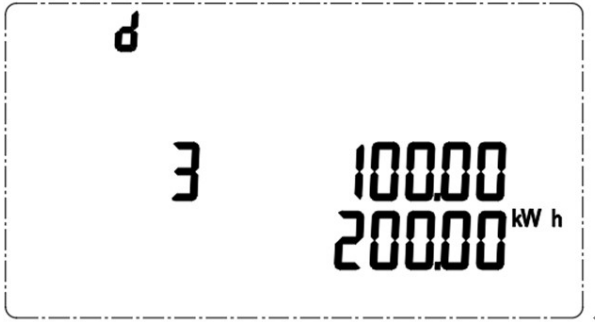



Figure 3

Figure 1 User 1 is a transformer access user, currently tripped, power consumption is 200 kWh, and the remaining amount is negative 100 yuan;

Figure 2 User 2 is a three-phase user, currently not tripped, power consumption is 200 kWh, and the remaining amount is 100 yuan:

Figure 3 User 3 is a single-phase user, currently not tripped, power consumption is 200 kWh, and the remaining amount is 100 yuan.

### 8.1 Swipe card display (only available with IC card swipe function)

In the remaining amount interface, press  In the display card reading, multiple card swiping operations can be performed within 10 seconds. However, you cannot re-swipe the card after the card is successfully swiped. If the card is wrong, you can continue to swipe the card. Swipe to display items as follows:

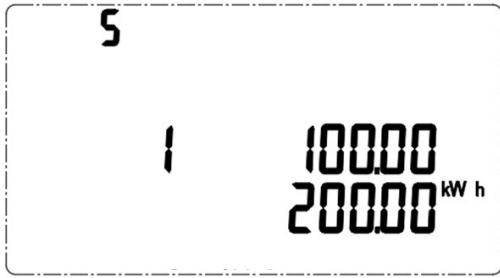

Remaining amount



Failed to read card



Card read successfully

If the card is incorrectly swiped, the energy meter shows that the card reading fails, and the error code and meaning correspond to the following:

error code	meaning
Err01	Write back failure
Err02	data error
Err03	Undefined card
Err04	This account opening card has been used
Err10	Insert the account opening card into the opened account meter
Err11	Insert the electricity purchase card into the meter without an account
Err12	User card error
Err13	Wrong number of purchases
Err14	Non-present card
Err15	Wrong account card type

## 8.2 Key display example

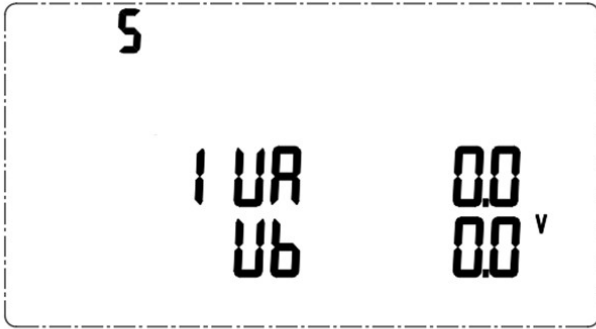

Phase voltage  $U_a$  and  $U_b$



Phase voltage  $U_c$  and line voltage  $U_{ab}$

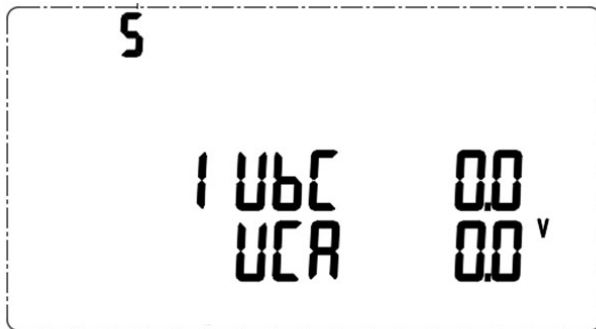

Line voltage  $U_{bc}$  and  $U_{ca}$

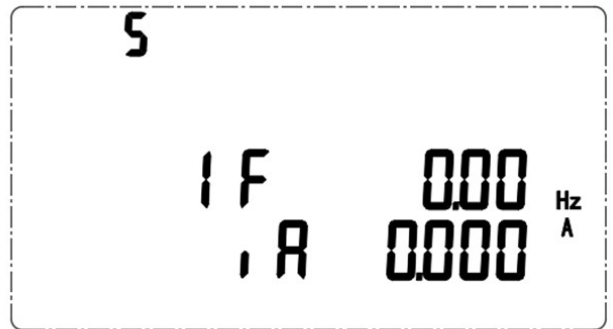

Frequency  $F$  and current  $I_a$

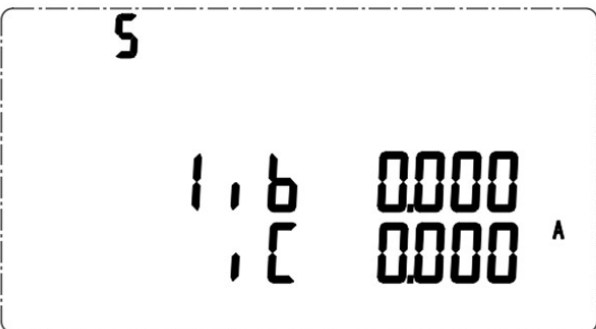

Current  $I_b$  and  $I_c$

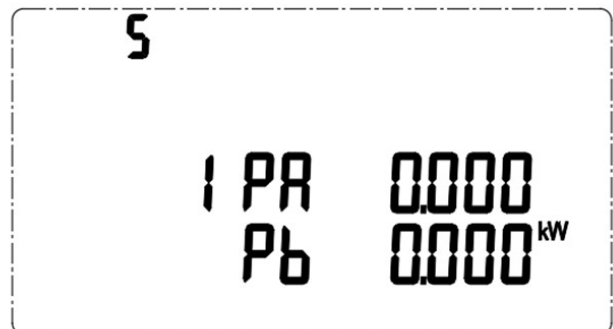

Active power  $P_a$  and  $P_b$

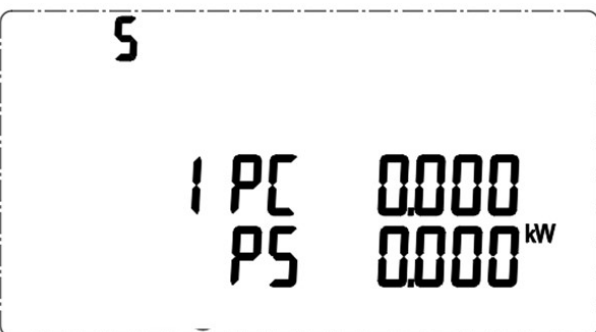

Active power  $P_c$  and total active power

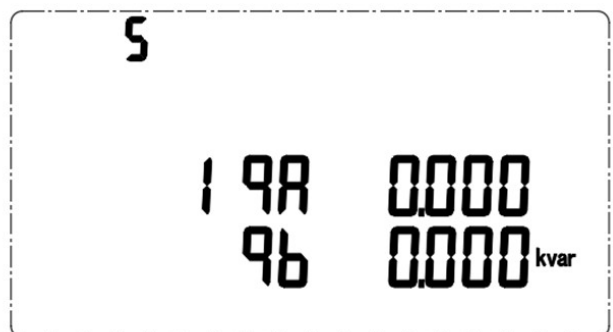

Reactive power  $Q_a$  and  $Q_b$



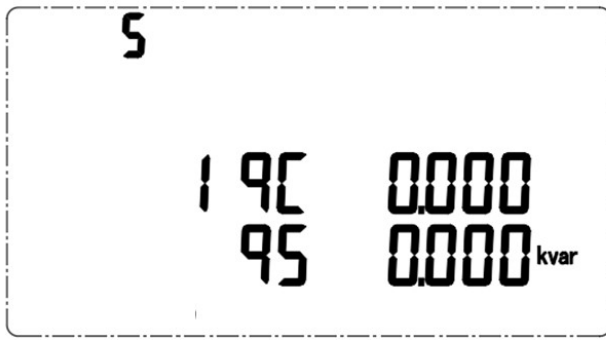

Reactive power  $Q_c$  and total reactive power

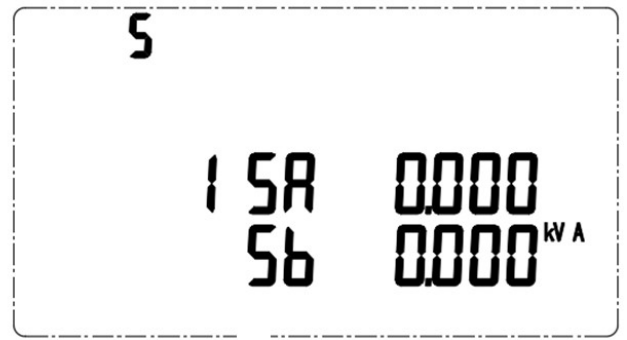

Apparent power  $S_a$  and  $S_b$

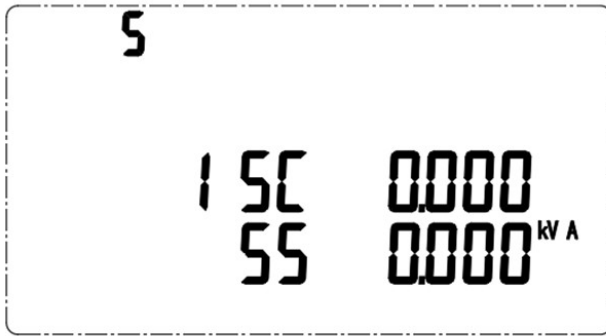

Apparent power  $S_c$  and total apparent power

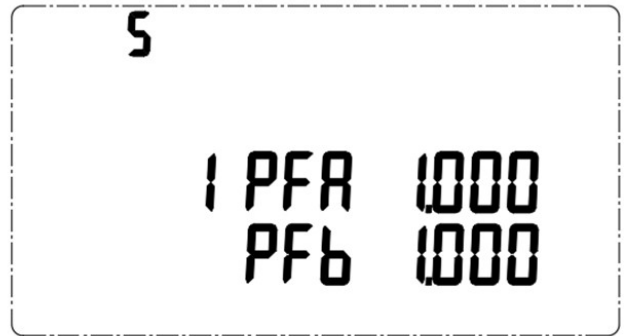

Power factor  $P_{fa}$  and  $P_{fb}$

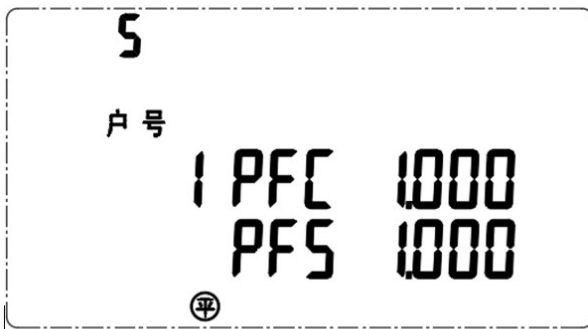

Power factor  $P_{FC}$  and total power factor



time

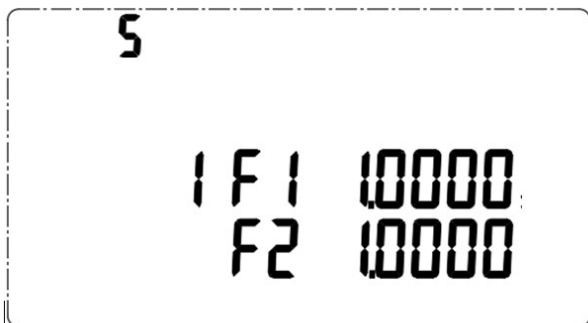

Peak price and peak price

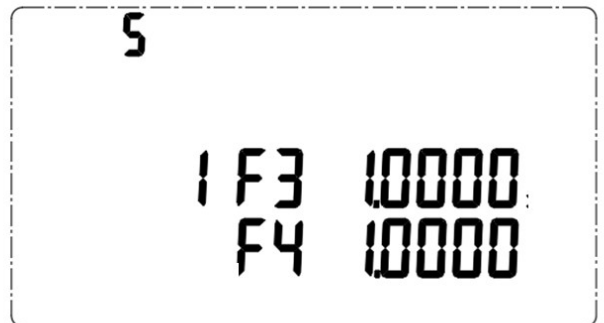

Flat electricity price and valley electricity price

### 8.3 Display switching operation

The remaining amount is displayed by default after power-on. The three types of view keys can be used to display the screen. The order of various display interfaces is described as follows:









: Switch user



: Remaining amount and total active power consumption, phase voltage, line voltage, frequency, current, active power, reactive power, apparent power, power factor, time, electricity price

### 8.4 Button programming

Under any display item in the measurement display menu, press  display “0000”, Prompt to enter the password (password default 0001) and then press  , If the password is entered incorrectly, it will return to the initial interface; if the password is entered correctly, you can set the parameters. After setting, press  enter “SAvE” interface, Press  appear “YES”、“NO” Options, “YES” Press down  Then save and exit, when “NO” Press  Then exit without saving. The programming menu list is as follows:

First level menu	Second level menu	Meaning	range
<b>Addr 1</b>	/	Mailing address settings 1	1、 37、 73、 109 ( Add sequentially 36) .....
<b>bAUd 1</b>	/	Baud rate selection 1	9600、 4800、 2400、 1200
<b>Addr 2</b>	/	Mailing address settings 2	1、 37、 73、 109 ( Add sequentially 36) .....
<b>bAUd 2</b>	/	Baud rate selection 2	9600、 4800、 2400、 1200
<b>Code</b>	/	password setting	0-9999
<b>блб, нб</b>	/	Backlight setting	0-999
<b>FCEn</b>	/	Strong control enable	0: Disable 1: Enable 2: invalid
<b>FCEtA</b>	/	Strong control state	0: disconnect 1: closure 2: invalid
<b>HPXnUñ</b>	/	Number of transformer	0、 2、 4、 6、 8、 10、 12



	<b>, P1</b>	Local IP address 1,2	
	<b>, P2</b>	Local IP address 3,4	
	<b>Port</b>	port	
<b>EnCrYPt</b>	/	Encryption switch settings	on: encryption on, oFF: encryption off
<b>UEr</b>	/	Software number and version number	

## 9 Communication description

### 9.1 Communication interface

ADF400L The series main module supports up to 3 RS485 communication interfaces, 1 infrared interface, and 1 CE Ethernet interface.

### 9.2 letter of agreement

The RS485 interface of this energy meter supports MODBUS and the Ethernet interface supports MODBUS-TCP protocol. For the specific protocol format, please refer to the relevant protocol standards, which will not be repeated here.

### 9.3 MODBUS communication address description

The address interval between each adjacent transformer access user and the three-phase user is 3, and the address interval for each single-phase user is 1.

Assuming that the table number is 1, there are 4 households with transformers connected, 4 households with three-phase direct access, and 12 households with single-phase direct access, then the transformer access user addresses are 1, 4, 7, 10, three-phase user addresses It is 13, 16, 19, 22, and the single-phase user address is 25, 26, 27,...36.

The meter number can be set by communication, the meter number connected to the same bus must be different, and the value of the meter number (1、37、73....).

### 9.4 MODBUS communication address table

initial address	data item	R/W	length	Base unit	Remarks
0x0300	Single phase voltage	R	2	0.1V	U (Unsigned integer, the same below)
0x0301	Single phase current	R	2	0.01A	U
0x0302	Single-phase active power	R	2	0.001kW	I (Signed integer, the same below)
0x0303	Single phase reactive power	R	2	0.001kvar	I
0x0304	Single phase power factor	R	2	0.001	I

0x0305	Single phase frequency	R	2	0.01Hz	U
0x0306	Single-phase active energy	R	4	0.01kWh	U
0x0307					
0x0308	Single-phase reactive energy	R	4	0.01kvarh	U
0x0309					
0x030A	Single-phase residual energy	R	4	0.01 kWh	I
0x030B					
0x030C	Single-phase total power purchase	R	4	0.01 kWh	U
0x030D					
0x030E	Single-phase power purchases	R	2	/	U
0x030F	Single-phase basic electricity	R	4	0.01 kWh	U
0x0310					
0x0311	Single-phase status word	R	2	/	U
0x0312	Single-phase basic power remaining	R	4	0.01 kWh	I
0x0313					
0x0314	Reserved	R	2	/	U
0x0315	Single-phase over-limit amount	R	4		U
0x0316					
0x0317	Recovery Time	R	2	/	U
0x0318	Recovery time overload value	R	2	1S	U
0x0319	Single-phase positive active energy	R	4	0.01kWh	U
0x031A					
0x031B	Unidirectional active energy	R	4	0.01kWh	U
0x031C					
0x031D	Single-phase forward reactive energy	R	4	0.01kvarh	U
0x031E					
0x031F	Single reverse reactive energy	R	4	0.01kvarh	U
0x0320					
0x033F	A Phase voltage	R	2	0.1V	U
0x0340	B Phase voltage	R	2	0.1V	U
0x0341	C Phase voltage	R	2	0.1V	U
0x0342	A Phase current	R	2	0.01A	U
0x0343	B Phase current	R	2	0.01A	U

0x0344	C Phase current	R	2	0.01A	U
0x0345	Total active power	R	2	1W	I
0x0346	A Phase active power	R	2	0.001kW	I
0x0347	B Phase active power	R	2	0.001kW	I
0x0348	C Phase active power	R	2	0.001kW	I
0x0349	Total reactive power	R	2	0.001kvar	I
0x034A	A Phase reactive power	R	2	0.001kvar	I
0x034B	B Phase reactive power	R	2	0.001kvar	I
0x034C	C Phase reactive power	R	2	0.001kvar	I
0x034D	Total power factor	R	2	0.001	I
0x034E	A Phase power factor	R	2	0.001	I
0x034F	B Phase power factor	R	2	0.001	I
0x0350	C Phase power factor	R	2	0.001	I
0x0351	frequency	R	2	0.01Hz	U
0x0352	A Phase active energy	R	4	0.01 kWh	U
0x0353					
0x0354	B Phase active energy	R	4	0.01 kWh	U
0x0355					
0x0356	C Phase active energy	R	4	0.01 kWh	U
0x0357					
0x0358	A Phase reactive energy	R	4	0.01kvarh	U
0x0359					
0x035A	B Phase reactive energy	R	4	0.01kvarh	U
0x035B					
0x035C	C Phase reactive energy	R	4	0.01kvarh	U
0x035D					
0x035E	Total active energy	R	4	0.01 kWh	U
0x035F					
0x0360	Total reactive energy	R	4	0.01kvarh	U
0x0361					
0x0362	Remaining amount	R	4	0.01 yuan	I
0x0363					
0x0364	Total purchase amount	R	4	0.01 yuan	U

0x0365					
0x0366	Number of power purchases	R	2	/	U
0x0367	Base amount	R	4	0.01 yuan	U
0x0368					
0x0369	Running status word	R	2	/	U
0x036A	Basic battery remaining	R	4	0.01 yuan	U
0x036B					
0x036C	Reserved	R	2	/	U
0x036D	Overdraft amount	R	2	/	U
0x036E					
0x036F	Recovery Time	R	2	1S	U
0x0370	Recovery time overload value	R	2	1S	U
0x0371	AB Line voltage	R	2	0.1V	U
0x0372	BC Line voltage	R	2	0.1V	U
0x0373	CA Line voltage	R	2	0.1V	U
0x0374	Zero sequence current	R	2	0.1A	U
0x0375	Voltage unbalance	R	2	0.01	U
0x0376	Current unbalance	R	2	0.01	U
0x0377	A Phase positive active energy	R	4	0.01kWh	U
0x0378					
0x0379	A Reverse phase active energy	R	4	0.01kWh	U
0x037A					
0x037B	B Phase positive active energy	R	4	0.01kWh	U
0x037C					
0x037D	B Reverse phase active energy	R	4	0.01kWh	U
0x037E					
0x037F	C Phase positive active energy	R	4	0.01kWh	U
0x0380					
0x0381	C Reverse phase active energy	R	4	0.01kWh	U
0x0382					
0x0383	A Phase positive reactive energy	R	4	0.01kvarh	U
0x0384					
0x0385	A Reverse phase reactive energy	R	4	0.01kvarh	U
0x0386					
0x0387	B Phase positive	R	4	0.01kvarh	U

0x0388	reactive energy				
0x0389	B reverse phase	R	4	0.01kvarh	U
0x038A	reactive energy				
0x038B	C Phase positive	R	4	0.01kvarh	U
0x038C	reactive energy				
0x038D	C reverse phase	R	4	0.01kvarh	U
0x038E	reactive energy				
0x038F	Total positive active	R	4	0.01kWh	U
0x0390	energy				
0x0391	Total reverse phase	R	4	0.01kWh	U
0x0392	active energy				
0x0393	Total positive reactive	R	4	0.01kvarh	U
0x0394	energy				
0x0395	Total reverse phase	R	4	0.01kvarh	U
0x0396	reactive energy				
Multiple rate area					
0x0400	Single-phase active tip	R	4	0.01 kWh	U
0x0401	electric energy				
0x0402	Single-phase active	R	4	0.01 kWh	U
0x0403	peak energy				
0x0404	Single-phase active	R	4	0.01 kWh	U
0x0405	power				
0x0406	Single-phase active	R	4	0.01 kWh	U
0x0407	valley electric energy				
0x0408	Single-phase reactive	R	4	0.01kvarh	U
0x0409	power				
0x040A	Single-phase reactive	R	4	0.01kvarh	U
0x040B	peak energy				
0x040C	Single-phase reactive	R	4	0.01kvarh	U
0x040D	power				
0x040E	Single-phase reactive	R	4	0.01kvarh	U
0x040F	valley electric energy				
0x0410	Single-phase positive	R/W	4	0.01 kWh	U
0x0411	active peak energy				



0x0412	Single-phase forward active peak energy	R/W	4	0.01 kWh	U
0x0413					
0x0414	Single-phase positive active energy	R/W	4	0.01 kWh	U
0x0415					
0x0416	Single-phase positive active valley energy	R/W	4	0.01 kWh	U
0x0417					
0x0418	Single reverse phase active tip electric energy	R/W	4	0.01 kWh	U
0x0419					
0x041A	Single reverse phase active peak energy	R/W	4	0.01 kWh	U
0x041B					
0x041C	Single reverse phase active power level energy	R/W	4	0.01 kWh	U
0x041D					
0x041E	Single phase reverse active valley energy	R/W	4	0.01 kWh	U
0x041F					
0x0420	Single-phase forward reactive power	R/W	4	0.01kvarh	U
0x0421					
0x0422	Single-phase forward reactive peak energy	R/W	4	0.01kvarh	U
0x0423					
0x0424	Single-phase forward reactive power	R/W	4	0.01kvarh	U
0x0425					
0x0426	Single-phase positive reactive valley energy	R/W	4	0.01kvarh	U
0x0427					
0x0428	Single reverse phase reactive peak electric energy	R/W	4	0.01kvarh	U
0x0429					
0x042A	Single reverse phase reactive peak energy	R/W	4	0.01kvarh	U
0x042B					
0x042C	Single reverse phase reactive power	R/W	4	0.01kvarh	U
0x042D					
0x042E	Single phase reverse reactive valley energy	R/W	4	0.01kvarh	U
0x042F					
0x0430	Three-phase active tip electric energy	R	4	0.01 kWh	U
0x0431					

0x0432	Three-phase active peak energy	R	4	0.01 kWh	U
0x0433					
0x0434	Three-phase active power	R	4	0.01 kWh	U
0x0435					
0x0436	Three-phase active valley electric energy	R	4	0.01 kWh	U
0x0437					
0x0438	Three-phase reactive peak electric energy	R	4	0.01kvarh	U
0x0439					
0x043A	Three-phase reactive peak power	R	4	0.01kvarh	U
0x043B					
0x043C	Three-phase reactive power	R	4	0.01kvarh	U
0x043D					
0x043E	Three-phase reactive valley electric energy	R	4	0.01kvarh	U
0x043F					
0x0440	Three-phase positive active peak energy	R/W	4	0.01 kWh	U
0x0441					
0x0442	Three-phase forward active peak energy	R/W	4	0.01 kWh	U
0x0443					
0x0444	Three-phase positive active energy	R/W	4	0.01 kWh	U
0x0445					
0x0446	Three-phase positive active valley electric energy	R/W	4	0.01 kWh	U
0x0447					
0x0448	Three opposite phase active peak electric energy	R/W	4	0.01 kWh	U
0x0449					
0x044A	Three opposite phase active peak energy	R/W	4	0.01 kWh	U
0x044B					
0x044C	Three opposite phase active power level energy	R/W	4	0.01 kWh	U
0x044D					
0x044E	Three-phase active valley electric energy	R/W	4	0.01 kWh	U
0x044F					
0x0450	Three-phase forward reactive power	R/W	4	0.01kvarh	U
0x0451					
0x0452	Three-phase forward	R/W	4	0.01kvarh	U

0x0453	reactive peak energy				
0x0454	Three-phase forward	R/W	4	0.01kvarh	U
0x0455	reactive power				
0x0456	Three-phase positive	R/W	4	0.01kvarh	U
0x0457	reactive valley electric energy				
0x0458	Three-phase reverse	R/W	4	0.01kvarh	U
0x0459	reactive peak electric energy				
0x045A	Three reverse phase	R/W	4	0.01kvarh	U
0x045B	reactive peak energy				
0x045C	Three-phase reactive	R/W	4	0.01kvarh	U
0x045D	power				
0x045E	Three-phase reactive	R/W	4	0.01kvarh	U
0x045F	valley electric energy				
Prepaid area					
0x0500	Single phase prepaid switch	R/W	2	/	U
0x0501	Single-phase peak	R/W	4	0.01 yuan/kWh	U
0x0502	price		4		U
0x0503	Single-phase peak		4		U
0x0504	electricity price		4		U
0x0505	Single-phase		4		U
0x0506	electricity price		4		U
0x0507	Single-phase valley	R/W	4	0.01 yuan	U
0x0508	price				
0x0509	Single-phase alarm	R/W	4	0.01 yuan	U
0x050A	amount 1				
0x050B	Single-phase alarm	R/W	4	0.01 yuan	U
0x050C	amount 2				
0x050D	Single-phase new	R/W	4	0.01yuan	U
0x050E	power purchase amount				
0x050F	Single-phase power purchases	R/W	2	/	U

0x0510	Single-phase basic amount	R/W	4	0.01yuan	U
0x0511					
0x0512	Single phase prepaid switch	R/W	2	/	U
0x0536	Three-phase prepaid switch	R/W	2	/	
0x0537	Three-phase peak price	R/W	4	0.01yuan/kWh	U
0x0538					
0x0539	Three-phase peak electricity price	R/W	4	0.01yuan/kWh	U
0x053A					
0x053B	Three-phase electricity price	R/W	4	0.01yuan/kWh	U
0x053C					
0x053D	Three-phase valley electricity price	R/W	4	0.01yuan/kWh	U
0x053E					
0x053F	Three-phase alarm amount 1	R/W	4	0.01yuan	U
0x0540					
0x0541	Three-phase alarm amount 2	R/W	4	0.01yuan	U
0x0542					
0x0543	Three-phase new power purchase amount	R/W	4	0.01yuan	U
0x0544					
0x0545	Three-phase power purchase	R/W	2	/	U
0x0546	Three-phase basic amount	R/W	4	0.01yuan	U
0x0547					
Time zone					
0x0600	Single-phase time control switch	R/W	2		U
0x0601	Switch 1, hour 1	R/W	8 x 3		Single-phase working day time control table U
0x0602	minute 1, switch 2				
0x0603	Time 2, off 2				
0x0604	switch 3, hour 3				
0x0605	minute 3, switch 4				
0x0606	Hour 4, minute 4				

0x0607	switch 5, Hour 5				
0x0608	Minute 5, switch 6				
0x0609	Hour 6, minute6				
0x060A	Switch 7, Hour 7				
0x060B	Minute 7, Switch 8				
0x060C	Hour 8, Minute 8				
0x060D	Switch 1, hour 1	R/W	8 x 3		Single-phase rest day time control table U
0x060E	minute 1, switch 2				
0x060F	Time 2, off 2				
0x0610	switch 3, hour 3				
0x0611	minute 3, switch 4				
0x0612	Hour 4, minute 4				
0x0613	switch 5, Hour 5				
0x0614	Minute 5, switch 6				
0x0615	Hour 6, minute6				
0x0616	Switch 7, Hour 7				
0x0617	Minute 7, Switch 8				
0x0618	Hour 8, Minute 8				
0x0619	Single phase rest day setting word				
0x064E	Three phase time control switch	R/W	2		U
0x064F	Switch 1, hour 1	R/W	8 x 3	/	Three-phase working day time control table U
0x0650	minute 1, switch 2				
0x0651	Time 2, off 2				
0x0652	switch 3, hour 3				
0x0653	minute 3, switch 4				
0x0654	Hour 4, minute 4				
0x0655	switch 5, Hour 5				
0x0656	Minute 5, switch 6				
0x0657	Hour 6, minute6				
0x0658	Switch 7, Hour 7				
0x0659	Minute 7, Switch 8				
0x065A	Hour 8, Minute 8				
0x065B	Switch 1, hour 1				
0x065C	minute 1, switch 2				

0x065D	Time 2, off 2				U
0x065E	switch 3, hour 3				
0x065F	minute 3, switch 4				
0x0660	Hour 4, minute 4				
0x0661	switch 5, Hour 5				
0x0662	Minute 5, switch 6				
0x0663	Hour 6, minute6				
0x0664	Switch 7, Hour 7				
0x0665	Minute 7, Switch 8				
0x0666	Hour 8, Minute 8				
0x0667	Three phase rest day setting word	R/W	2	/	U
Load control area					
0x0700	Single phase load control switch	R/W	2	/	U
0x0701	Single phase maximum power threshold	R/W	2	0.001kW	U
0x0702	Single phase active power increment threshold	R/W	2	0.001kW	U
0x0703	Single phase power factor threshold	R/W	2	/	U
0x0704	Single phase load control times	R/W	2	/	U
0x0705	Single phase load control allow times	R/W	2	/	U
0x0706	Single phase load control recovery time	R/W	2	10s	U
0x0707	Single phase voltage loss threshold	R/W	2	0.1V	U
0x0718	Three phase load control switch	R/W	2	/	U
0x0719	Three phase maximum power threshold	R/W	2	0.001kW	U

0x071A	Three phase active power increment threshold	R/W	2	0.001kW	U
0x071B	Three phase power factor threshold	R/W	2	/	U
0x071C	Three phase load control times	R/W	2	/	U
0x071D	Three phase load control allow times	R/W	2	/	U
0x071E	Three phase load control recovery time	R/W	2	10s	U
0x071F	Three phase voltage loss threshold	R/W	2	0.1V	U
Strong control zone					
0x0800	Single three-phase category	R/W	2	/	0: Three-phase, 1: Single-phase
0x0801	Single-phase strong control's control word	R/W	2	/	High bit 1: open, low bit 1: closed
0x0804	Three-phase strong control's control word	R/W	2	/	High bit 1: open, low bit 1: closed
System parameter area					
0x0900	address 1	R/W	2	/	0~247
0x0901	Baud rate 1	R/W	2	/	High Byte: Check digit 0: NONE 1: ODD 2: EVEN Low Byte: Baud Rate 0: 9600 1: 9600 2: 4800 3: 2400 4: 1200
0x0902	password	R/W	2	/	

0x0903	Number of three-phase circuits directly connected	R/W	2	/	0~12
0x0904	Number of single-phase circuits directly connected	R/W	2	/	0~36
0x0908	Protocol selection	R/W	2	/	High byte 0: Prepaid 1: Metering type Low byte 0: modbus
0x0909	Force control mark	R/W	2	/	not enabled
0x090A	Whether the IC card is enabled	R/W	2	/	
0x090B	Second/minute	R/W	2	/	
0x090C	Hour/week	R/W	2	/	
0x090D	Sun / month	R/W	2	/	
0x090E	Year/reserved	R/W	2	/	
0x090F	Type (number of single-phase circuits)	R/W	2	/	0:36 1:24 2:12
0x0910	Total number of single-phase circuits	R/W	2	/	Total circuit number of cabinet (single phase)
0x0911	Address 2	R/W	2	/	The second address
0x0912	Baud rate 2	R/W	2	/	High Byte: Check digit 0: NONE 1: ODD 2: EVEN Low Byte:Baud Rate 0: 9600 1: 9600 2: 4800 3: 2400 4: 1200
0x0913	Vacant lower board control word	R/W	2	/	Not Enabled
0x0914	Time period 1, hour 1	R/W	14 x 3		Multiple rate period 1



0x0915	Minute 1, period 2				U
0x0916	Hour 2, minute 2				
0x0917	Period 3, hour 3				
0x0918	Minute 3, period 4				
0x0919	Hour 4, minute 4				
0x091A	Time period 5, hour 5				
0x091B	Minute 5, period 6				
0x091C	Hour 6 minutes 6				
0x091D	Time period 7, hour 7				
0x091E	Minute 7, period 8				
0x091F	Hours 8 minutes 8				
0x0920	Time period 9, hour 9				
0x0921	Minute 9, period 10				
0x0922	Hour 10, minute 10				
0x0923	Time 11, hour 11				
0x0924	Minute 11, period 12				
0x0925	Hour 12, minute 12				
0x0926	Time period 13, hour 13				
0x0927	Minute 14, period 14				
0x0928	Hours 14 minutes 14				
0x0929	Time period 1, hour 1	R/W	14 x 3		
0x092A	Minute 1, period 2				
0x092B	Hour 2, minute 2				
0x092C	Period 3, hour 3				
0x092D	Minute 3, period 4				
0x092E	Hour 4, minute 4				
0x092F	Time period 5, hour 5				
0x0930	Minute 5, period 6				Multi-rate schedule 2
0x0931	Hour 6 minutes 6				U
0x0932	Time period 7, hour 7				
0x0933	Minute 7, period 8				
0x0934	Hours 8 minutes 8				
0x0935	Time period 9, hour 9				
0x0936	Minute 9, period 10				
0x0937	Hour 10, minute 10				

0x0938	Time 11, hour 11				
0x0939	Minute 11, period 12				
0x093A	Hour 12, minute 12				
0x093B	Time period 13, hour 13				
0x093C	Minute 14, period 14				
0x093D	Hours 14 minutes 14				
0x093E	Timetable number/date: day	R/W	4 x 3		Time zone table U
0x093F	Date: month/timetable number				
0x0940	Date: Day/Date: Month				
0x0941	Timetable number/date: day				
0x0942	Date: month/timetable number				
0x0943	Date: Day/Date: Month				
0x0944	Order number 1,2				U
0x0945	Order number 3, 4				U
0x0946	Backlight time				U
0x0947	Serial number [0][1]				
0x0948	Serial number[2][3]				
0x0949	Serial number[4][5]				
0x094A	Serial number[6][7]				
0x094B	Serial number[8][9]				
0x094C	Serial number[10][11]				
0x094D	Serial number[12][13]				
0x094E	Switch DI state	R			See table 1
0x094F	Switch DO status	R/W			See table 1
0x0950	Line selection	R/W			0:3P4L 1:3P3L
0x0951	PT	R/W			1-9999
0x0952	CT1	R/W			1-9999
0x0953	CT2	R/W			1-9999
0x0954	CT3	R/W			1-9999
0x0955	CT4	R/W			1-9999
0x0956	CT5	R/W			1-9999

0x0957	CT6	R/W			1-9999
0x0958	CT7	R/W			1-9999
0x0959	CT8	R/W			1-9999
0x095A	CT9	R/W			1-9999
0x095B	CT10	R/W			1-9999
0x095C	CT11	R/W			1-9999
0x095D	CT12	R/W			1-9999
0x095E	output method	R/W			0: L level 1: P pulse
0x095F	Pulse Width	R/W			Default 500 unit ms
0x0960	Pulse interval	R/W			Default 30 unit s
0x0961	Whether wireless is enabled	R/W			0: Disable 1: Enable
0x0962	Number of transformer access circuits	R/W	2	/	0~12
0x0963	Slave address rearrangement	R/W	2	/	0: Disable 1: Enable
0x0964	Enable CE Ethernet	R/W	2	/	0: Disable 1: Enable
0x0965	Address 3	R/W	2	/	The third address
0x0966	Baud rate 3	R/W	2	/	High Byte: Check digit 0: NONE 1: ODD 2: EVEN Low Byte: Baud Rate 0: 9600 1: 9600 2: 4800 3: 2400 4: 1200
0x0967	Debug information switch	R/W	2	/	
0x0968	Gateway IP[0][1]	R/W	2		
0x0969	Gateway IP[2][3]	R/W	2		
0x096A	Subnet mask [0][1]	R/W	2		
0x096B	Subnet mask[2][3]	R/W	2		
0x096C	IP[0][1]				
0x096D	IP[2][3]				
0x096E	MAC address[0][1]	R	2		

0x096F	MAC address[2][3]	R	2		
0x0970	MAC address[4][5]	R	2		
0x0971	The port number	R/W	2		
0x0972	DI debounce time	R/W	2		
Switch area					
0x1800	Switch DI state	R			See table 2
0x1801	Switch DO status	R/W			See table 2
Harmonic region					
0x1900	A phase voltage total harmonic content rate	R	2		
0x1901	A phase voltage 2nd harmonic content rate	R	2		
0x1902	A phase voltage 3rd harmonic content rate	R	2		
...	...	...	...		
0x191E	A phase voltage 31st harmonic content rate	R	2		
0x191F	B-phase voltage total harmonic content rate	R	2		
0x1920	B-phase voltage 2nd harmonic content rate	R	2		
0x1921	B-phase voltage 3rd harmonic content rate	R	2		
...	...	...	...		
0x193D	31st harmonic content rate of phase B voltage	R	2		
0x193E	C-phase voltage total harmonic content rate	R	2		
0x193F	C-phase voltage 2nd harmonic content rate	R	2		
0x1940	C-phase voltage 3rd harmonic content rate	R	2		
...	...	...	...		
0x195C	C-phase voltage 31st harmonic content rate	R	2		
0x195D	A phase current total harmonic content rate	R	2		
0x195E	A phase current 2nd harmonic content rate	R	2		

0x195F	A phase current 3rd harmonic content rate	R	2		
...	...	...	...		
0x197B	A phase current 31st harmonic content rate	R	2		
0x197C	B-phase current total harmonic content rate	R	2		
0x197D	B-phase current 2nd harmonic content rate	R	2		
0x197E	B-phase current 3rd harmonic content rate	R	2		
...	...	...	...		
0x199A	B-phase current 31st harmonic content rate	R	2		
0x199B	C-phase current total harmonic content rate	R	2		
0x199C	C-phase current 2nd harmonic content rate	R	2		
0x199D	C-phase current 3rd harmonic content rate	R	2		
...	...	...	...		
0x19B9	C-phase current 31st harmonic content rate	R	2		
Historic Power District					
0x1A00	Historical energy data for the previous month	R	20		Format Freezing time: year and month Freezing time: day hour Active peak energy Active peak energy Active flat energy Active valley energy
0x1A01	Historical electric energy data for the last two months	R	20		
0x1A02	Historical energy data for the last three months	R	20		
0x1A03	Historical energy data for the last April	R	20		
0x1A04	Historical energy data for the last May	R	20		
0x1A05	Historical electric energy data for last June	R	20		
0x1A06	Historical energy data for the last July	R	20		
0x1A07	Historical energy data for the last August	R	20		

0x1A08	Historical energy data for the last September	R	20		
0x1A09	Historical electrical energy data for the last October	R	20		
0x1A0A	Historical energy data for the last November	R	20		
0x1A0B	Historical electric energy data for last December	R	20		
Recharge record area					
0x1B00	Last recharge record block	R	20		Format Recharge time: Years and months Recharge time: Days and hours Recharge time: minutes and seconds Number of power purchases Power purchase amount Remaining amount after power purchase Total power consumption
0x1B01	Last 2 recharge record blocks	R	20		
0x1B02	Last 3 recharge record blocks	R	20		
0x1B03	Last 4 recharge record blocks	R	20		
0x1B04	Last 5 recharge record blocks	R	20		
0x1B05	Last 6 recharge record blocks	R	20		
0x1B06	Last 7 recharge record blocks	R	20		
0x1B07	Last 8 recharge record blocks	R	20		
0x1B08	Last 9 recharge record blocks	R	20		
0x1B09	Last 10 recharge record blocks	R	20		
0x1B0A	Last 11 recharge record blocks	R	20		
0x1B0B	Last 12 recharge record blocks	R	20		
0x1B0C	Last 13 recharge record blocks	R	20		
0x1B0D	Last 14 recharge record blocks	R	20		
0x1B0E	Last 15 recharge record blocks	R	20		
0x1B0F	Last 16 recharge record blocks	R	20		
0x1B10	Last 17 recharge	R	20		

	record blocks			
0x1B11	Last 18 recharge record blocks	R	20	
0x1B12	Last 19 recharge record blocks	R	20	
0x1B13	Last 20 recharge record blocks	R	20	

Table 1

	9~16	8	7	6	5	4	3	2	1
094EH	Reserved							DI2	DI1
094FH	Reserved							DO2	DO1

Table 2

	9~16	8	7	6	5	4	3	2	1
1800H	Reserved								DI1
1800H	Reserved							DO2	DO1

## 10 Common troubleshooting

- No communication

Check whether the communication line connection is reliable, whether 485A, 485B are correspondingly connected;

Enter the menu setting item to observe whether the address and baud rate options are set correctly;

Use a multimeter to measure whether the voltage of the 485A and 485B ports is about 4V. If the cabinet has been connected to the 485 bus, the 485 line of the cabinet must be disconnected from the bus before the measurement.

- The meter measures abnormal voltage and current

Check whether the wiring is correct and whether the joint is tightly pressed.

- Abnormal power measurement

Check if the phase sequence of incoming line ABC is correct.

### Manual revision record

date	old version	new version	Modify content
2020.3.19		V1.0	1. First time writing

**The issuance of control-related commands is not detailed in the manual due to space reasons. If necessary, please contact our customer service.**

Headquarters:AcrelCo.,LTD.  
Address:No.253YulvRoadJiadingDistrict,Shanghai , China  
TEL.:+8617821101655  
Web-site:[www.acrel-group.com](http://www.acrel-group.com)  
E-mail:[Lynn@acrel-electric.com](mailto:Lynn@acrel-electric.com)  
Postcode:201801